

TECHNICAL INFORMATION

APPLICATION	Airflow direction	Horizontal, vertical
	Airflow type	Linear / exhaust or supply
CONSTRUCTION	Shape	Square
	Min. length	294 x 294 mm
	Max. length	819 x 819 mm
	Height	11 mm
MATERIAL	Standard material	Powder coated steel, PVC deflectors
	Standard finishing	RAL9010
	Product finishing options	Powder coating RAL, black/white deflectors
MOUNTING	Mounting options	Central screw
PLENUM BOX	Perforated pressure distribution plate	Yes
	Spigot	Class D spigot with double lip seal
	Volume control	Perforated volume flow control disk inside the spigot
	Material	Galvanised steel sheet, PP/TPE spigot
	Optional insulation	Melamine 6mm
	Mounting options	mounting eyes (Ø7mm) standard, mounting brackets available

QUICK SELECTION

WT100-S SUPPLY - OPEN VALVE

Qv [m³/h]	L _w		
	25 dB(A)	30 dB(A)	35 dB(A)
125	101 m³/h	119 m³/h	140 m³/h
160	128 m³/h	153 m³/h	184 m³/h
200	262 m³/h	307 m³/h	359 m³/h
250	333 m³/h	390 m³/h	458 m³/h
315	452 m³/h	535 m³/h	634 m³/h

WT100

SQUARE SWIRL DIFFUSER WITH ADJUSTABLE RADIAL AIR PATTERN

Variations [WT100-S](#) [WT100-T](#)



Square steel swirl diffuser type WT100 with adjustable radial air pattern is used for the supply of cooled or heated air in facilities such as offices, shopping centres, schools, ... Diffusers for ceiling or exposed duct mounting. The square diffuser offered, complete with a plenum box with side- or top connection. The diffuser is equipped with adjustable PVC deflectors creating the possibility to obtain an external or internal swirl. A high induction is obtained by the exceptional swirl discharge, which makes them extremely suitable for VAV terminal boxes.

Square steel swirl diffuser with adjustable air pattern, complete with a plenum box with side or top entry

The diffuser is equipped with adjustable deflectors

Easy to install, multiple mounting options available



ACCESSORIES

WP100

Plenum box

WP100P

Pyramid plenum box

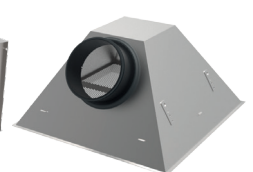
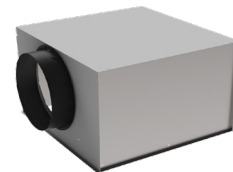

SECTION + MONTAGE

SIZE (NUMBER OF DEFLECTORS)

125 (9)

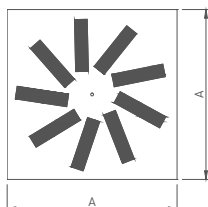

160 (12)

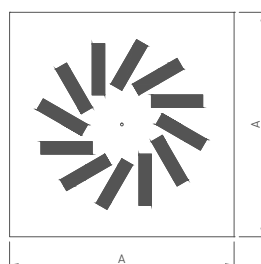

200 (24)

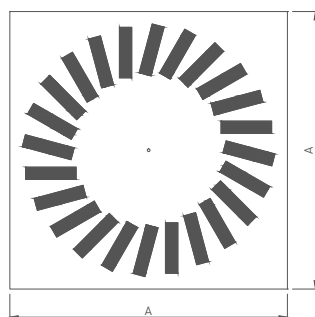

250 (36)

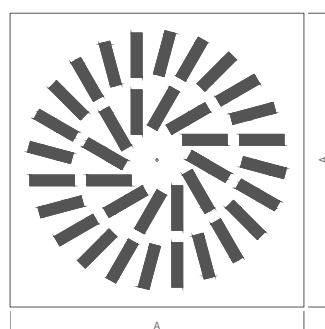

315 (48)

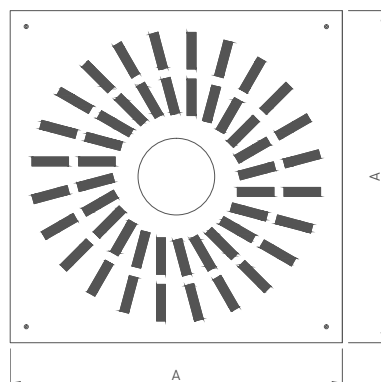

i Size 315 mm

An adjustable deflector sheet is mounted in the central part allowing you to handle 25 % more air volume compared to size 250 mm, without any increase in noise.

connection top

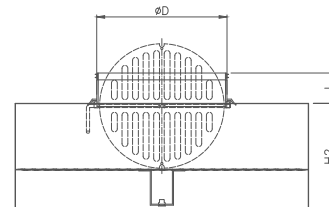
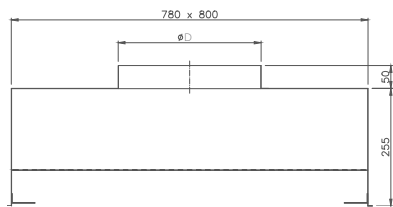

connection side

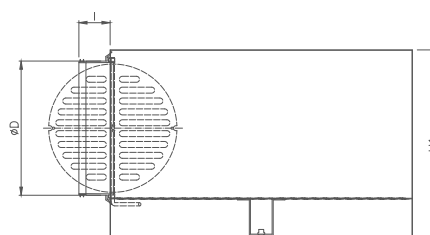
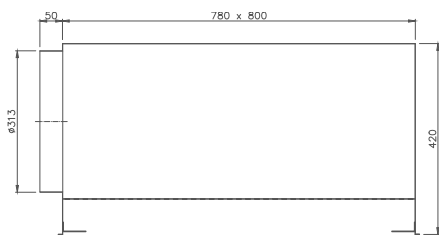

panel

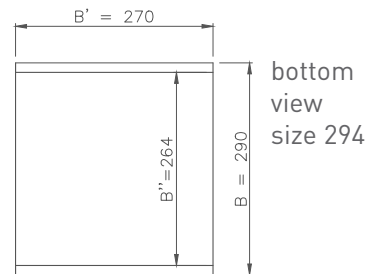
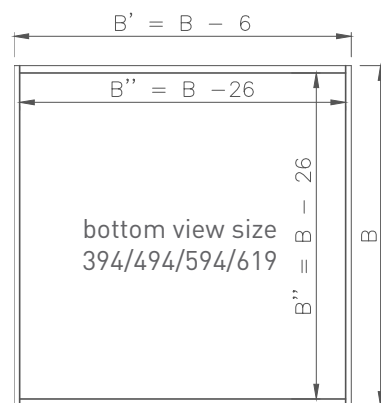
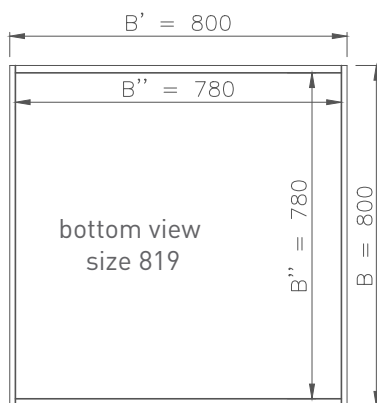
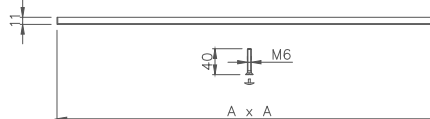
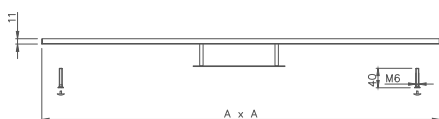

SIZE	A	B	B'	B''	D	I	H1	H2	deflectors
125	294	290	270	264	123	58	230	155	9
160	394	380	374	354	158	58	265	205	12
200	494	480	474	454	198	58	305	205	24
250	594	580	574	554	248	78	355	205	36
250	619	580	574	554	248	78	355	205	36
315	819	800	800	780	313	50	420	255	48

All dimensions in mm.

SQUARE SWIRL DIFFUSER WITH ADJUSTABLE RADIAL AIR PATTERN

WT100-S WT100-T

HOW TO ORDER ?

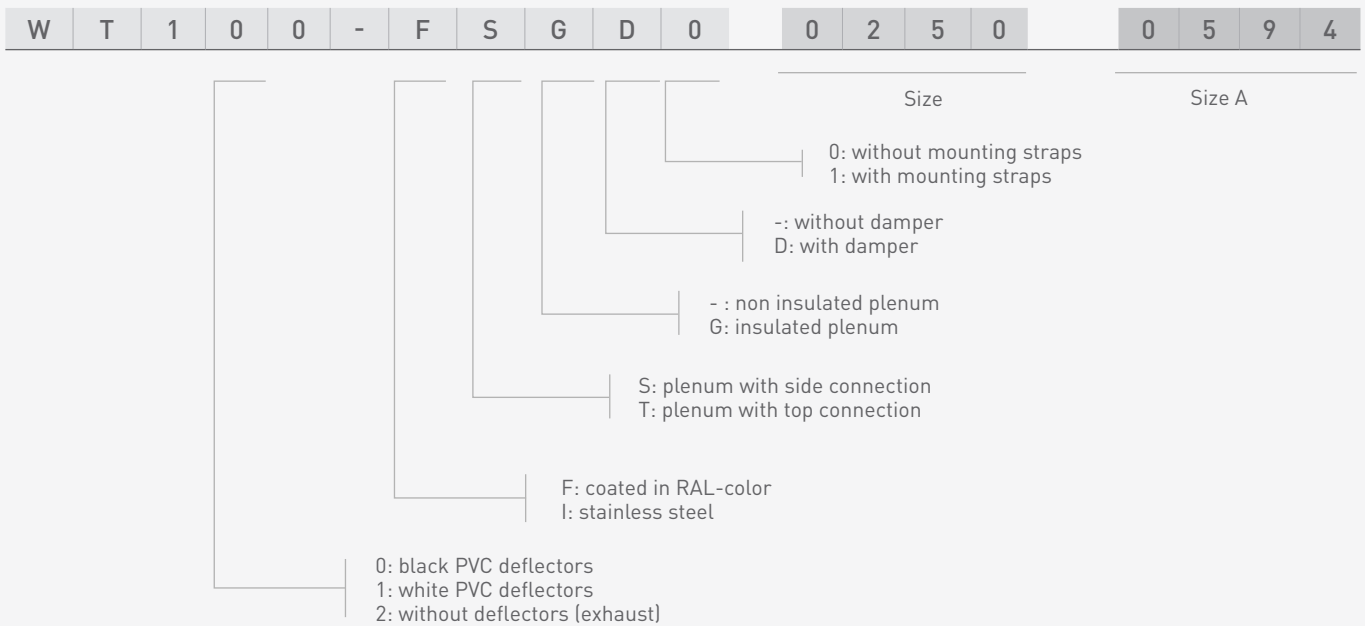
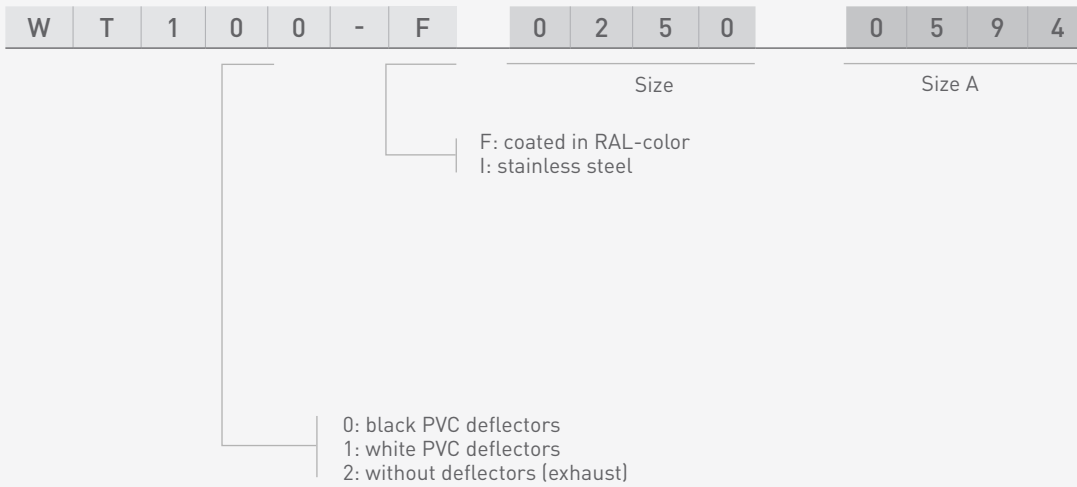

SQUARE SWIRL DIFFUSER WITH ADJUSTABLE RADIAL AIR PATTERN

WT100-S;WT100-TT

